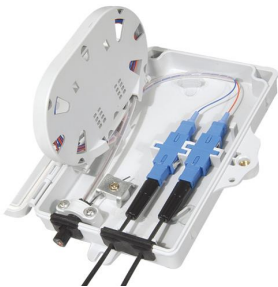

FTTx Fiber Access Terminal Box

Fiber access terminal box (FAT) also named as optical termination box (OTB), is a compact fiber management box which used for FTTH application. Fiber termination box (FTB) is widely used in FTTx cabling for both fiber cabling and cable management. The Fiber terminal boxes have wall mount and pole mount installation with material of plastic or metal body optional. Optical termination boxes are designed for either pre-connectorized cables, field installation of connectors, or field splicing of pigtails. They offer an ideal solution for building entrance terminals, telecommunication closets, main cross-connects, computer rooms and other controlled environments.

P/N and Specifications

Item No.	FLK-FAT-202A	Protection Grade: IP55
Outside dimension	168x102x32mm	
Material of Box body	ABS plastic	
Input cable diameter	1x ϕ 4-12mm	
Drop cable diameter	2x ϕ 3-5mm	
Adapter Type	2xSC Simplex	
Splice Capacity	2 fibers	
PLC Splitter (Optional)	1x2 or 1x4 Micro Splitter	

P/N and Specifications

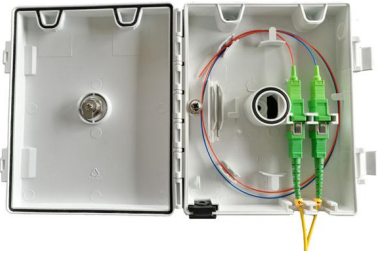
Item No.	FLK-FAT-202B	Protection Grade: IP55
Outside dimension	150x120x37mm	
Material of Box body	ABS plastic	
Input cable diameter	1x ϕ 4-12mm	
Drop cable diameter	2x ϕ 3-5mm	
Adapter Type	2xSC Simplex	
Splice Capacity	2 fibers	
PLC Splitter (Optional)	N/A	

P/N and Specifications

Item No.	FLK-FAT-202C	Protection Grade: IP65
Outside dimension	210x156x48mm	
Material of Box body	PC+ABS plastic	
Cable ports diameter	2*Cable gland of M20x1.5mm	
Adapter Type	2xSC Simplex	
Splice Capacity	2xSC or 4xLC fibers	
PLC Splitter (Optional)	N/A	

P/N and Specifications

Item No.	FLK-FAT-204A	Protection Grade: IP55
Outside dimension	186x120x40mm	
Material of Box body	ABS plastic	
Input cable diameter	1xφ4-12mm	
Drop cable diameter	4xφ3-5mm	
Adapter Type	4xSC Simplex	
Splice Capacity	4 fibers	
PLC Splitter (Optional)	1x2 or 1x4 Micro Splitter	

P/N and Specifications

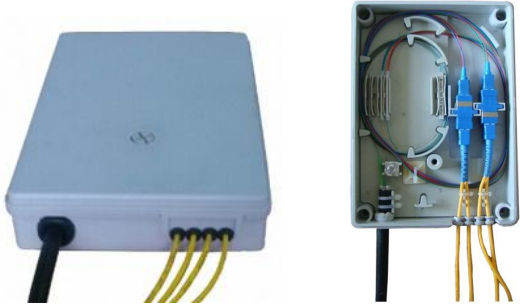
Item No.	FLK-FAT-204B	Protection Grade: IP55
Outside dimension	185x135x35mm	
Material of Box body	ABS plastic	
Input cable diameter	1xφ4-12mm	
Drop cable diameter	4xφ3-5mm	
Adapter Type	4xSC Simplex	
Splice Capacity	4 fibers	
PLC Splitter (Optional)	1x2 or 1x4 Micro Splitter	

P/N and Specifications

Item No.	FLK-FAT-204C	Protection Grade: IP55
Outside dimension	190x155x40mm	
Material of Box body	ABS plastic	
Input cable diameter	1xφ4-12mm	
Drop cable diameter	4xφ3-5mm	
Adapter Type	4xSC Simplex	
Splice Capacity	4 fibers	
PLC Splitter (Optional)	1x2 or 1x4 Micro Splitter	

P/N and Specifications

Item No.	FLK-FAT-204E	Protection Grade: IP65
Outside dimension	191x120x44mm	
Material of Box body	PC+ABS plastic	
Input cable diameter	1xPG16	
Drop cable diameter	4xφ3-5mm	
Adapter Type	4xSC Simplex	
Splice Capacity	4 fibers	
PLC Splitter (Optional)	1x2 or 1x4 Micro Splitter	

P/N and Specifications

Item No.	FLK-FAT-206A	Protection Grade: IP55
Outside dimension	186x120x40mm	
Material of Box body	ABS plastic	
Input cable diameter	1xφ4-12mm	
Drop cable diameter	6xφ3-5mm	
Adapter Type	6xSC Simplex	
Splice Capacity	6 fibers	
PLC Splitter (Optional)	1x2 or 1x4 Micro Splitter	

P/N and Specifications

Item No.	FLK-FAT-206B	Protection Grade: IP55
Outside dimension	172x136x40mm	
Material of Box body	ABS plastic	
Input cable diameter	1xφ4-12mm	
Drop cable diameter	6xφ3-5mm	
Adapter Type	6xSC Simplex	
Splice Capacity	6 fibers	
PLC Splitter (Optional)	1x2 or 1x4 Micro Splitter	

P/N and Specifications

Item No.	FLK-FAT-208A1	Protection Grade: IP55
Outside dimension	228x182x55mm	
Material of Box body	PC+ABS plastic	
Input cable diameter	2xφ7-12mm (PG13.5)	
Drop cable diameter	8xφ3-5mm	
Adapter Type	8xSC Simplex	
Splice Capacity	8 fibers	
PLC Splitter (Optional)	1x4 or 1x8 Micro Splitter	

P/N and Specifications

Item No.	FLK-FAT-208A2	Protection Grade: IP55
Outside dimension	228x182x55mm	
Material of Box body	PC+ABS plastic	
Input cable diameter	3xφ7-15mm	
Drop cable diameter	8xφ3-5mm	
Adapter Type	8xSC Simplex	
Splice Capacity	8 fibers	
PLC Splitter (Optional)	1x4 or 1x8 Micro Splitter	

P/N and Specifications

Item No.	FLK-FAT-208A3	Protection Grade: IP55																
Outside dimension	220x225x55mm	 <p>Comparison table for choosing Adapters of optical box</p> <table border="1"> <tr><td>1</td><td>2</td><td>3</td><td>4</td></tr> <tr><td>5</td><td>6</td><td>7</td><td>8</td></tr> <tr><td>9</td><td>10</td><td>11</td><td>12</td></tr> <tr><td>13</td><td>14</td><td>15</td><td>16</td></tr> </table> <p>Outdoor Optical Distribution Box</p> <p>Item No. Product date Made by Contact No.</p> <p>FDB</p>	1	2	3	4	5	6	7	8	9	10	11	12	13	14	15	16
1	2		3	4														
5	6		7	8														
9	10		11	12														
13	14		15	16														
Material of Box body	PC+ABS plastic																	
Input cable diameter	2x ϕ 7-12mm (PG13.5)																	
Drop cable diameter	8x ϕ 3-5mm																	
Adapter Type	8xSC Simplex																	
Splice Capacity	8 fibers																	
PLC Splitter (Optional)	1x4 or 1x8 Micro Splitter	Wall-mount or Pole mount																

P/N and Specifications

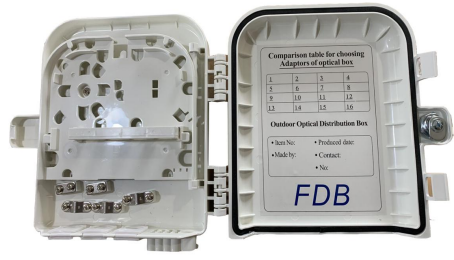
Item No.	FLK-FAT-208A4	Protection Grade: IP55																
Outside dimension	220x225x55mm	 <p>Comparison table for choosing Adapters of optical box</p> <table border="1"> <tr><td>1</td><td>2</td><td>3</td><td>4</td></tr> <tr><td>5</td><td>6</td><td>7</td><td>8</td></tr> <tr><td>9</td><td>10</td><td>11</td><td>12</td></tr> <tr><td>13</td><td>14</td><td>15</td><td>16</td></tr> </table> <p>Outdoor Optical Distribution Box</p> <p>Item No. Product date Made by Contact No.</p> <p>FDB</p>	1	2	3	4	5	6	7	8	9	10	11	12	13	14	15	16
1	2		3	4														
5	6		7	8														
9	10		11	12														
13	14		15	16														
Material of Box body	PC+ABS plastic																	
Input cable diameter	3x ϕ 7-15mm																	
Drop cable diameter	8x ϕ 3-5mm																	
Adapter Type	8xSC Simplex																	
Splice Capacity	8 fibers																	
PLC Splitter (Optional)	1x4 or 1x8 Micro Splitter	Wall-mount or Pole mount																

P/N and Specifications

Item No.	FLK-FAT-208A5	Protection Grade: IP55																
Outside dimension	220x225x55mm	 <p>Comparison table for choosing Adapters of optical box</p> <table border="1"> <tr><td>1</td><td>2</td><td>3</td><td>4</td></tr> <tr><td>5</td><td>6</td><td>7</td><td>8</td></tr> <tr><td>9</td><td>10</td><td>11</td><td>12</td></tr> <tr><td>13</td><td>14</td><td>15</td><td>16</td></tr> </table> <p>Outdoor Optical Distribution Box</p> <p>Item No. Product date Made by Contact No.</p> <p>FDB</p>	1	2	3	4	5	6	7	8	9	10	11	12	13	14	15	16
1	2		3	4														
5	6		7	8														
9	10		11	12														
13	14		15	16														
Material of Box body	PC+ABS plastic																	
Input cable diameter	2x ϕ 7-12mm (PG13.5)																	
Drop cable diameter	8x ϕ 3-5mm																	
Adapter Type	9xSC Simplex																	
Splice Capacity	8 fibers																	
PLC Splitter	1x8 Cassette Splitter	Wall-mount or Pole mount																

P/N and Specifications

Item No.	FLK-FAT-208A6	Protection Grade: IP55
Outside dimension	245x205x69mm	
Material of Box body	PC+ABS plastic	
Input cable diameter	2x ϕ 7-12mm (PG13.5)	
Drop cable diameter	8x ϕ 3-5mm	
Adapter Type	8xSC Simplex	
Splice Capacity	8 fibers	
PLC Splitter (Optional)	1x4 or 1x8 Micro Splitter	

P/N and Specifications

Item No.	FLK-FAT-208B	Protection Grade: IP65
Outside dimension	210x170x50mm	
Material of Box body	PC+ABS plastic	
Input cable diameter	3xφPG16	
Drop cable diameter	N/A	
Adapter Type	8xSC Simplex	
Splice Capacity	8 fibers	
PLC Splitter (Optional)	1x4 or 1x8 Micro Splitter	

P/N and Specifications

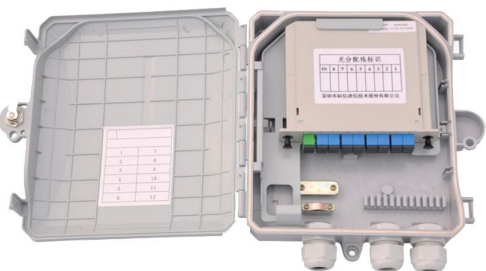
Item No.	FLK-FAT-208C	Protection Grade: IP55
Outside dimension	220x205x55mm	
Material of Box body	PC+ABS plastic	
Input cable diameter	3xφPG16	
Drop cable diameter	N/A	
Adapter Type	9xSC Simplex	
Splice Capacity	8 fibers	
PLC Splitter	1x8 Cassette Splitter	

P/N and Specifications

Item No.	FLK-FAT-208D	Protection Grade: IP55
Outside dimension	212x126x50mm	
Material of Box body	PC+ABS plastic	
Input cable diameter	2xφ10mm	
Drop cable diameter	8xφ3-5mm	
Adapter Type	8xSC Simplex	
Splice Capacity	12/24 fibers	
PLC Splitter (Optional)	1x4 or 1x8 Micro Splitter	

P/N and Specifications

Item No.	FLK-FAT-208E	Protection Grade: IP65
Outside dimension	213x163x47mm	
Material of Box body	PC+ABS plastic	
Input cable diameter	1xφPG16	
Drop cable diameter	8xφ3-5mm	
Adapter Type	8xSC Simplex	
Splice Capacity	8 fibers	
PLC Splitter (Optional)	N/A	

P/N and Specifications

Item No.	FLK-FAT-208F (Flip cover)	Protection Grade: IP55
Outside dimension	170x130x44mm	
Material of Box body	PC+ABS plastic	
Input cable diameter	2xφ10mm	
Drop cable diameter	8xφ3-5mm	
Adapter Type	8xSC Simplex	
Splice Capacity	8 fibers	
PLC Splitter (Optional)	1x4 or 1x8 Micro Splitter	

P/N and Specifications

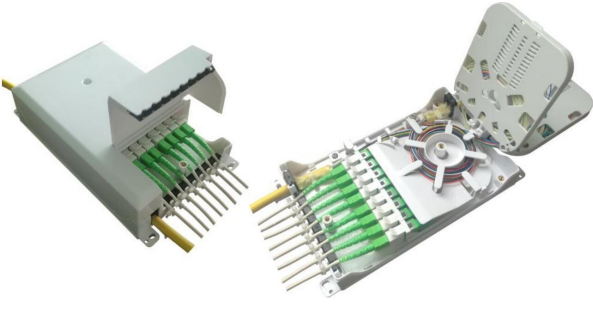
Item No.	FLK-FAT-208G (Flip cover)	Protection Grade: IP55
Outside dimension	212x126x50mm	
Material of Box body	PC+ABS plastic	
Input cable diameter	2xφ10mm	
Drop cable diameter	8xφ3-5mm	
Adapter Type	8xSC Simplex	
Splice Capacity	12/24 fibers	
PLC Splitter (Optional)	1x4 or 1x8 Micro Splitter	

P/N and Specifications

Item No.	FLK-FAT-212A	Protection Grade: IP55
Outside dimension	230x200x66mm	
Material of Box body	ABS plastic	
Input cable diameter	1xPG16	
Drop cable diameter	12xφ3-5mm	
Adapter Type	12xSC Simplex	
Splice Capacity	12 fibers	
PLC Splitter (Optional)	1x4 or 1x8 Micro Splitter	

P/N and Specifications

Item No.	FLK-FAT-212B	Protection Grade: IP55
Outside dimension	225x200x65mm	
Material of Box body	ABS plastic	
Input cable diameter	2xφ7-14mm	
Drop cable diameter	12xφ3-5mm	
Adapter Type	12xSC Simplex	
Splice Capacity	12 fibers	
PLC Splitter (Optional)	1x4 or 1x8 Micro Splitter	

P/N and Specifications

Item No.	FLK-FAT-212C	Protection Grade: IP65
Outside dimension	258x186x61mm	
Material of Box body	PC+ABS plastic	
Input cable diameter	1xPG13.5	
Output cable diameter	2xPG16	
Adapter Type	6xSC Duplex	
Splice Capacity	12 fibers	
PLC Splitter (Optional)	N/A	

P/N and Specifications

Item No.	FLK-FAT-212D	Protection Grade: IP55
Outside dimension	250x200x72mm	
Material of Box body	PC+ABS plastic	
Input cable diameter	2xφ7-14mm	
Drop cable diameter	12xφ3-5mm	
Adapter Type	12xSC Simplex	
Splice Capacity	12 fibers	
PLC Splitter (Optional)	1x4 or 1x8 Micro Splitter	

P/N and Specifications

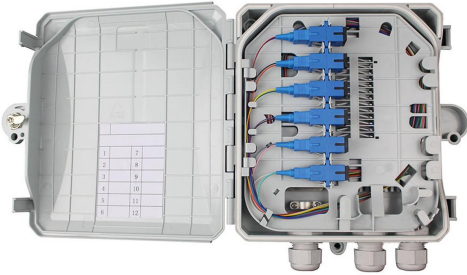
Item No.	FLK-FAT-212E	Protection Grade: IP55
Outside dimension	220x200x50mm	
Material of Box body	ABS plastic	
Input cable diameter	1xPG13.5	
Output cable diameter	2xPG13.5	
Adapter Type	12xSC Simplex	
Splice Capacity	12 fibers	
PLC Splitter (Optional)	N/A	

P/N and Specifications

Item No.	FLK-FAT-212F	Protection Grade: IP65
Outside dimension	274x175x82mm	
Material of Box body	PC+ABS plastic	
Input cable diameter	2xφ14mm+2xPG13.5	
Output cable diameter	2xPG13.5	
Adapter Type	12xφ3-5mm	
Splice Capacity	12 fibers	
PLC Splitter (Optional)	N/A	

P/N and Specifications

Item No.	FLK-FAT-216A	Protection Grade: IP55
Outside dimension	320x260x90mm	
Material of Box body	ABS plastic	
Input cable diameter	2xφ7-14mm	
Drop cable diameter	16×φ3-5mm	
Adapter Type	16xSC Simplex	
Splice Capacity	16 fibers	
PLC Splitter (Optional)	1x8 or 1x16 Micro Splitter	

P/N and Specifications

Item No.	FLK-FAT-216B	Protection Grade: IP55
Outside dimension	295x240x85mm	
Material of Box body	ABS plastic	
Input cable diameter	3xφ14mm for uncut cable	
Drop cable diameter	2xPG16	
Adapter Type	16xSC Simplex	
Splice Capacity	16 fibers	
PLC Splitter (Optional)	1x8 or 1x16 Micro Splitter	

P/N and Specifications

Item No.	FLK-FAT-216C	Protection Grade: IP65
Outside dimension	274x175x82mm	
Material of Box body	ABS plastic	
Input cable diameter	2xPG13.5	
Drop cable diameter	16×φ3-5mm	
Adapter Type	16xSC Simplex	
Splice Capacity	16 fibers	
PLC Splitter (Optional)	1x8 or 1x16 Micro Splitter	

P/N and Specifications

Item No.	FLK-FAT-216D	Protection Grade: IP55
Outside dimension	295x220x85mm	
Material of Box body	PC+ABS plastic	
Input cable diameter	2xPG13.5	
Drop cable diameter	16×φ3-5mm	
Adapter Type	16xSC Simplex	
Splice Capacity	16 fibers	
PLC Splitter (Optional)	1x8 or 1x16 Micro Splitter	

P/N and Specifications

Item No.	FLK-FAT-216E	Protection Grade: IP65
Outside dimension	340x220x95mm	
Material of Box body	PC+ABS plastic	
Input cable diameter	2xPG13.5	
Drop cable diameter	16×φ3-5mm	
Adapter Type	16xSC Simplex	
Splice Capacity	96 fibers (4 trays)	
PLC Splitter (Optional)	N/A	

P/N and Specifications

Item No.	FLK-FAT-216F	Protection Grade: IP65
Outside dimension	340x220x95mm	
Material of Box body	PC+ABS plastic	
Input cable diameter	2xPG13.5	
Drop cable diameter	16×φ3-5mm	
Adapter Type	16xSC Simplex	
Splice Capacity	16 fibers	
PLC Splitter (Optional)	1x8 or 1x16 Micro Splitter	

P/N and Specifications

Item No.	FLK-FAT-216G	Protection Grade: IP65
Outside dimension	340x220x95mm	
Material of Box body	PC+ABS plastic	
Input cable diameter	2xPG13.5	
Drop cable diameter	16×φ3-5mm	
Adapter Type	16xSC Simplex	
Splice Capacity	16 fibers	
PLC Splitter (Optional)	1x8 or 1x16 Cassette Splitter	

P/N and Specifications

Item No.	FLK-FAT-216H	Protection Grade: IP65
Outside dimension	385x245x130mm	
Material of Box body	PC+ABS plastic	
Input cable diameter	1xMid span of 17mm +2xPG16	
Drop cable diameter	16×φ3-5mm	
Adapter Type	16xSC Simplex	
Splice Capacity	96 fibers (4 trays)	
PLC Splitter (Optional)	3*1x8 Micro Splitter	

P/N and Specifications

Item No.	FLK-FAT-216K	Protection Grade: IP55
Outside dimension	220x140x55mm	
Material of Box body	ABS plastic	
Input cable diameter	2x ϕ 14mm for uncut cable	
Drop cable diameter	16x ϕ 3-5mm	
Adapter Type	16xSC Simplex	
Splice Capacity	16 fibers	
PLC Splitter (Optional)	1x8 or 1x16 Micro Splitter	

P/N and Specifications

Item No.	FLK-FAT-216M	Protection Grade: IP55
Outside dimension	315x260x125mm	
Material of Box body	PP+GF plastic	
Input cable diameter	ϕ 5-15mm	
Drop cable diameter	16x ϕ 3-5mm	
Adapter Type	16xSC Simplex	
Splice Capacity	16 fibers	
PLC Splitter (Optional)	1x8 or 1x16 Micro Splitter	

P/N and Specifications

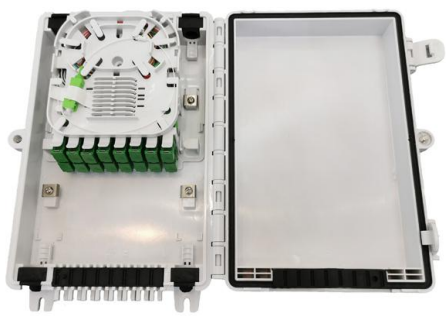
Item No.	FLK-FAT-216N	Protection Grade: IP55
Outside dimension	232x152x60mm	
Material of Box body	PC+ABS plastic	
Input cable diameter	4x ϕ 4-12mm	
Drop cable diameter	16x ϕ 3-5mm	
Adapter Type	16xSC Simplex	
Splice Capacity	16 fibers	
PLC Splitter (Optional)	1x8 or 1x16 Micro Splitter	

P/N and Specifications

Item No.	FLK-FAT-216P	Protection Grade: IP65
Outside dimension	287x172x102mm	
Material of Box body	PC+ABS plastic	
Input cable diameter	2xPG13.5	
Drop cable diameter	16x ϕ 3-5mm	
Adapter Type	16xSC Simplex	
Splice Capacity	16 fibers	
PLC Splitter (Optional)	1x8 or 1x16 Micro Splitter	

P/N and Specifications

Item No.	FLK-FAT-224A	Protection Grade: IP55
Outside dimension	320x240x100mm	
Material of Box body	PC+ABS plastic	
Input cable diameter	2xφ7-15mm	
Drop cable diameter	24×φ3-5mm	
Adapter Type	24xSC Simplex	
Splice Capacity	24 fibers	
PLC Splitter (Optional)	1x8 or 1x16 Micro Splitter	

P/N and Specifications

Item No.	FLK-FAT-224B	Protection Grade: IP55
Outside dimension	330x286x110mm	
Material of Box body	PC+ABS plastic	
Input cable diameter	8xφ7-15mm	
Drop cable diameter	24×φ3-5mm	
Adapter Type	24xSC Simplex	
Splice Capacity	72 fibers	
PLC Splitter (Optional)	1x8 or 1x16 Micro Splitter	

P/N and Specifications

Item No.	FLK-FAT-224C	Protection Grade: IP65
Outside dimension	340x250x110mm	
Material of Box body	PC+ABS plastic	
Input cable diameter	2xφ7-15mm	
Drop cable diameter	24×φ3-5mm	
Adapter Type	24xSC Simplex	
Splice Capacity	24 fibers	
PLC Splitter (Optional)	1x8 or 1x16 Micro Splitter	

P/N and Specifications

Item No.	FLK-FAT-224D1	Protection Grade: IP65
Outside dimension	385x245x130mm	
Material of Box body	PC+ABS plastic	
Input cable diameter	1xMid span of 17mm	
Drop cable diameter	24×φ3-5mm	
Adapter Type	24xSC Simplex	
Splice Capacity	96 fibers (4 trays)	
PLC Splitter (Optional)	2*1x8 Micro Splitter	

P/N and Specifications

Item No.	FLK-FAT-224D2	Protection Grade: IP65
Outside dimension	385x245x150mm	
Material of Box body	PC+ABS plastic	
Input cable diameter	1xMid span of 17mm+2xPG16	
Drop cable diameter	24xφ3-5mm	
Adapter Type	24xSC Simplex	
Splice Capacity	144 fibers (6 trays)	
PLC Splitter (Optional)	3*1x8 Micro Splitter	
		Wall-mount or Pole mount

P/N and Specifications

Item No.	FLK-FAT-224E	Protection Grade: IP65
Outside dimension	340x220x95mm	
Material of Box body	PC+ABS plastic	
Input cable diameter	2xPG13.5	
Drop cable diameter	24xφ3-5mm	
Adapter Type	24xSC Simplex	
Splice Capacity	96 fibers (4 trays)	
PLC Splitter (Optional)	N/A	
		Wall-mount or Pole mount

P/N and Specifications

Item No.	FLK-FAT-224F	Protection Grade: IP55
Outside dimension	380x293x115mm	
Material of Box body	PC+ABS plastic	
Input cable diameter	2xφ7-15mm	
Drop cable diameter	24xφ3mm	
Adapter Type	24xSC Simplex	
Splice Capacity	24 fibers	
PLC Splitter (Optional)	N/A	
		Wall-mount or Pole mount

P/N and Specifications

Item No.	FLK-FAT-224G	Protection Grade: IP65
Outside dimension	340x350x120mm	
Material of Box body	PC+ABS plastic	
Input cable ports	2xφ24mm	
Output cable diameter	2xφ16mm	
Adapter Type	24xSC Simplex	
Splice Capacity	24 fibers	
PLC Splitter (Optional)	N/A	
		Wall-mount or Pole mount

P/N and Specifications

Item No.	FLK-FAT-324A	Protection Grade: IP55
Outside dimension	296x245x94.5mm	
Material of Box body	PC+ABS plastic	
Input cable diameter	2xφ25mm	
Drop cable diameter	5xφ15mm	
Adapter Type	24xSC Simplex	
Splice Capacity	144 fibers (6 trays)	
PLC Splitter (Optional)	1x8 or 1x16 Micro Splitter	

P/N and Specifications

Item No.	FLK-FAT-324B	Protection Grade: IP55
Outside dimension	296x245x94.5mm	
Material of Box body	PC+ABS plastic	
Input cable diameter	2xφ22mm	
Drop cable diameter	4xφ11mm + 8xφ10mm	
Adapter Type	24xSC Simplex	
Splice Capacity	144 fibers (6 trays)	
PLC Splitter (Optional)	1x8 or 1x16 Micro Splitter	

P/N and Specifications

Item No.	FLK-FAT-324C	Protection Grade: IP55
Outside dimension	296x245x94.5mm	
Material of Box body	PC+ABS plastic	
Input cable diameter	2xφ22mm	
Drop cable diameter	4xφ11mm + 8xφ10mm	
Adapter Type	N/A	
Splice Capacity	144 fibers (6 trays)	
PLC Splitter (Optional)	1x8 or 1x16 Micro Splitter	

P/N and Specifications

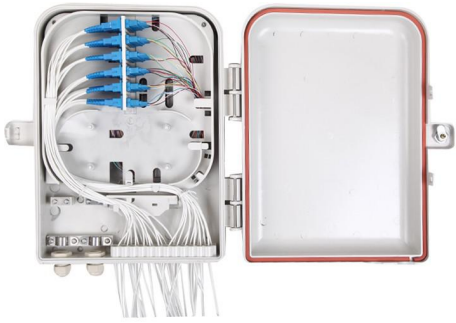
Item No.	FLK-FAT-236A	Protection Grade: IP55
Outside dimension	420x370x125mm	
Material of Box body	PC+ABS plastic	
Input cable diameter	2xPG16	
Drop cable diameter	36xφ3-5mm	
Adapter Type	36xSC Simplex	
Splice Capacity	36 fibers (4 trays)	
PLC Splitter (Optional)	1x16 or 1x32 Micro Splitter	

P/N and Specifications

Item No.	FLK-FAT-248A	Protection Grade: IP65
Outside dimension	340x350x120mm	
Material of Box body	PC+ABS plastic	
Input cable diameter	2xφ24mm	
Drop cable diameter	2xφ16mm	
Adapter Type	48xSC Simplex	
Splice Capacity	96 fibers (4 trays)	
PLC Splitter (Optional)	1x16 or 1x32 ABS Module Splitter	

P/N and Specifications

Item No.	FLK-FAT-248B	Protection Grade: IP65
Outside dimension	400x310x120mm	
Material of Box body	PC+ABS plastic	
Input cable diameter	2xφ24mm	
Drop cable diameter	2xφ18mm+2xφ14mm	
Adapter Type	48xSC Simplex	
Splice Capacity	48 fibers (2 trays)	
PLC Splitter (Optional)	1x16 or 1x32 Micro Splitter	

P/N and Specifications

Item No.	FLK-FAT-248C	Protection Grade: IP65
Outside dimension	425x345x125mm	
Material of Box body	ABS plastic	
Entry cable port	4xPG21	
Adapter Type	48xSC Simplex	
Splice Capacity	48 fibers (2 trays)	
PLC Splitter (Optional)	1x16 or 1x32 Micro Splitter	

P/N and Specifications

Item No.	FLK-FAT-272A	Protection Grade: IP65
Outside dimension	340x350x120mm	
Material of Box body	PC+ABS plastic	
Input cable diameter	2xφ24mm	
Drop cable diameter	2xφ16mm	
Adapter Type	72xSC Simplex	
Splice Capacity	96 fibers (4 trays)	
PLC Splitter (Optional)	1x32 or 1x64 ABS Module Splitter	